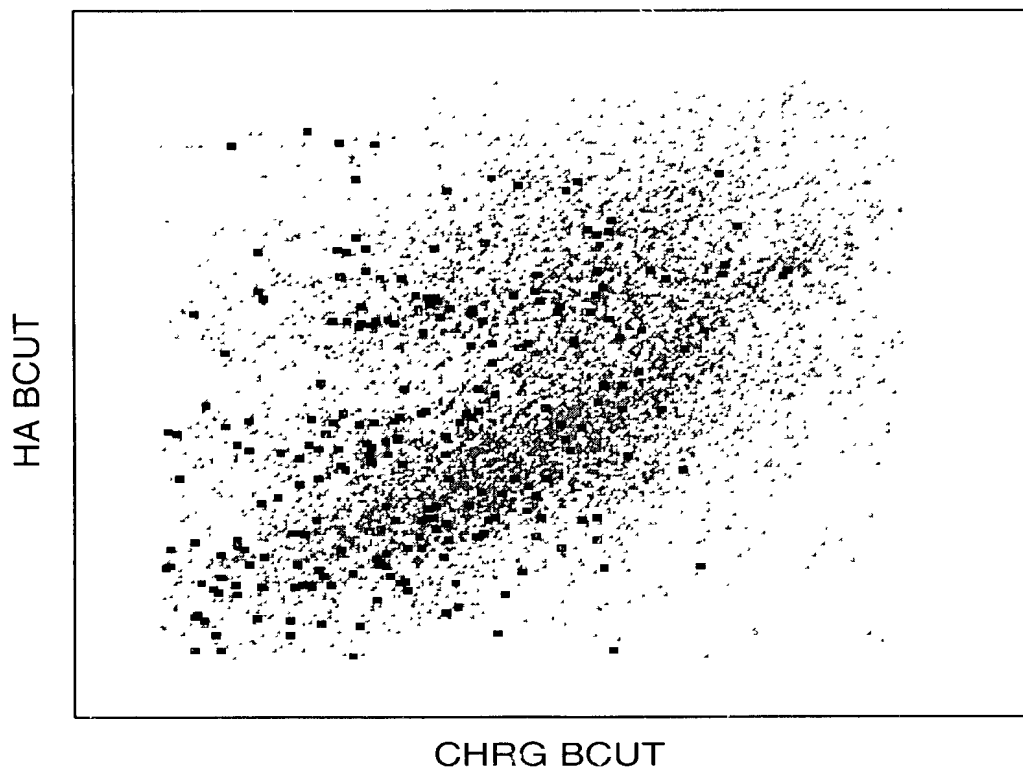


Fig. 1

2/17



**Fig. 2**

3/17

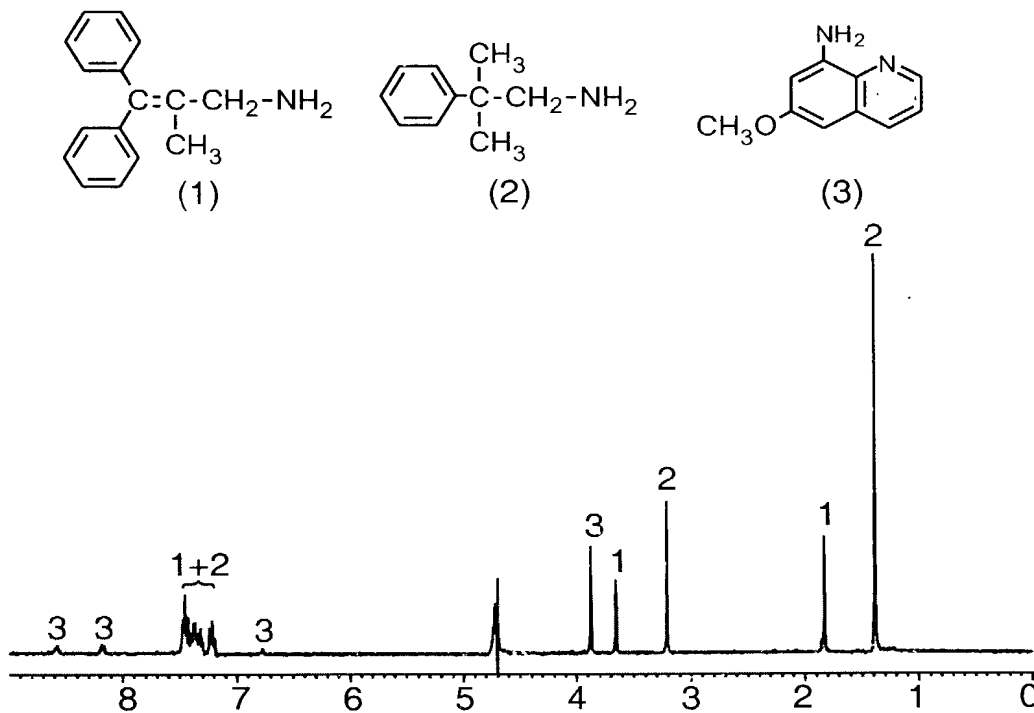


Fig. 3A

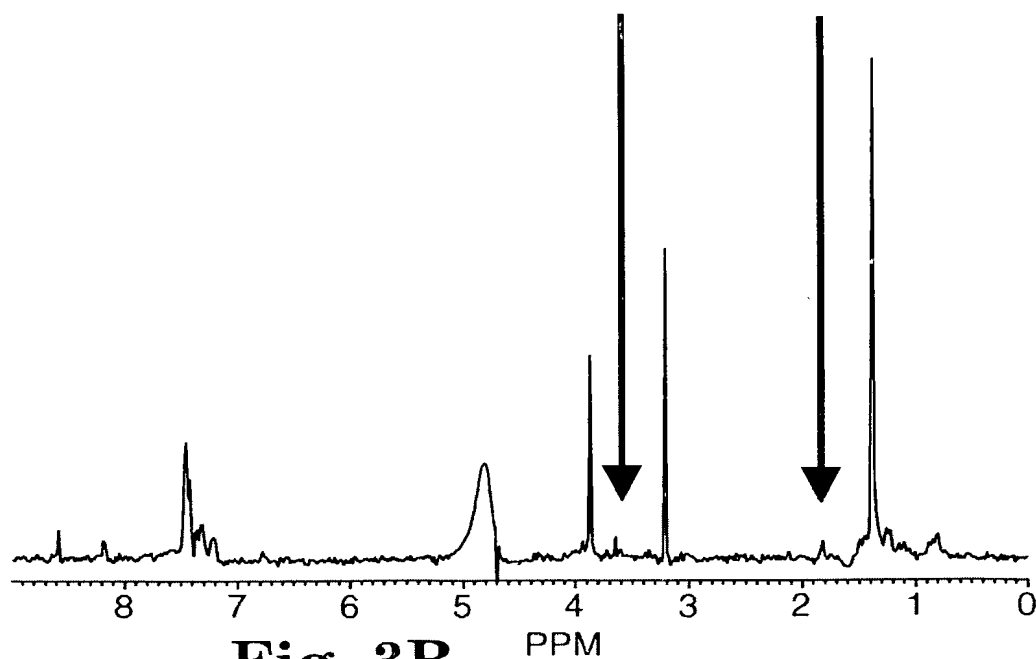


Fig. 3B

PPM

4/17

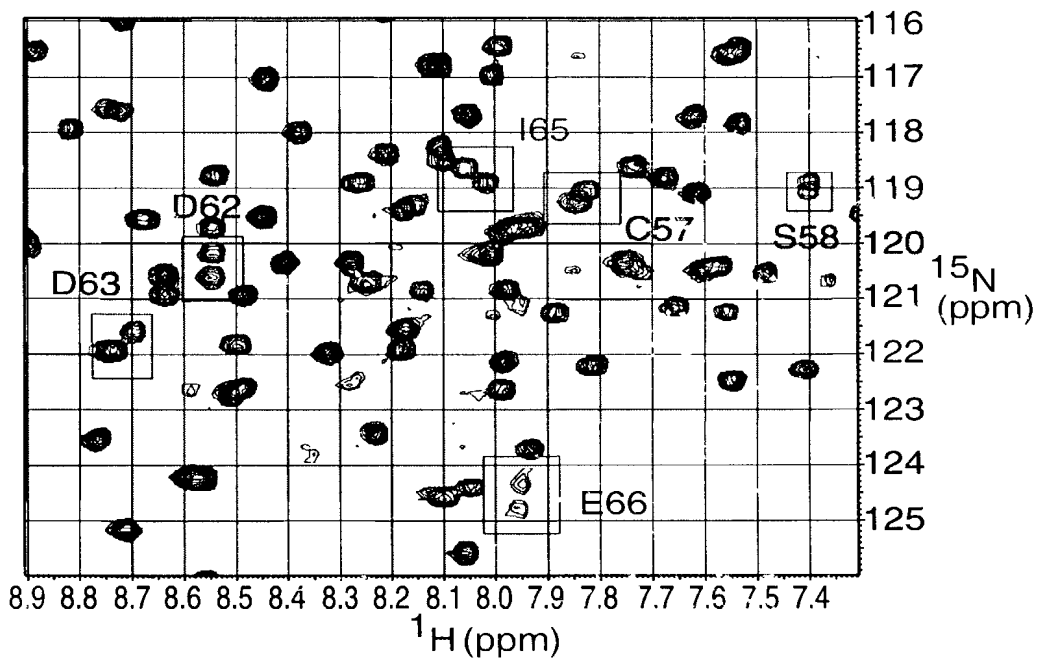
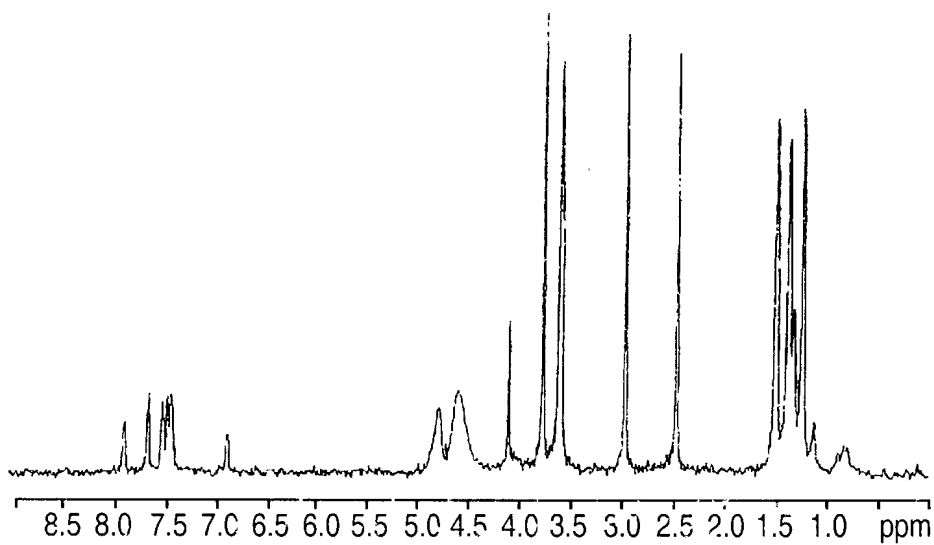


Fig. 4A

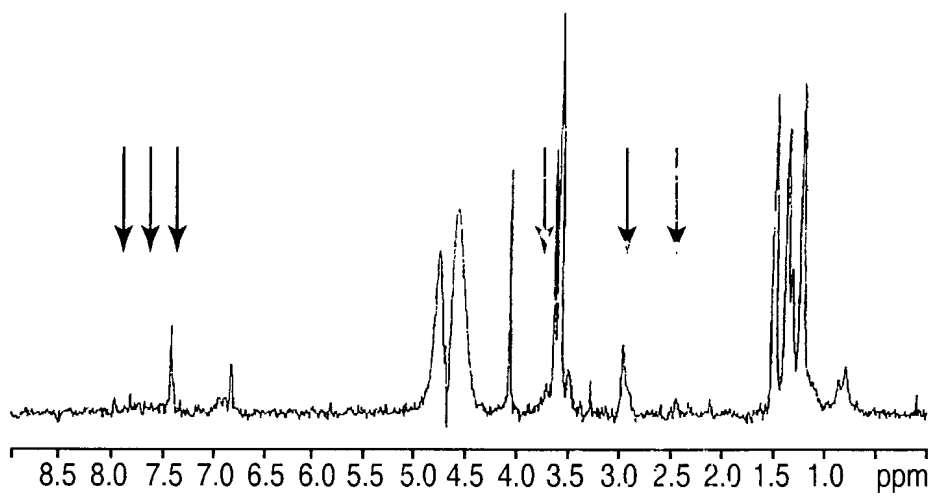


Fig. 4B

5/17



**Fig. 5A**



**Fig. 5B**

6/17

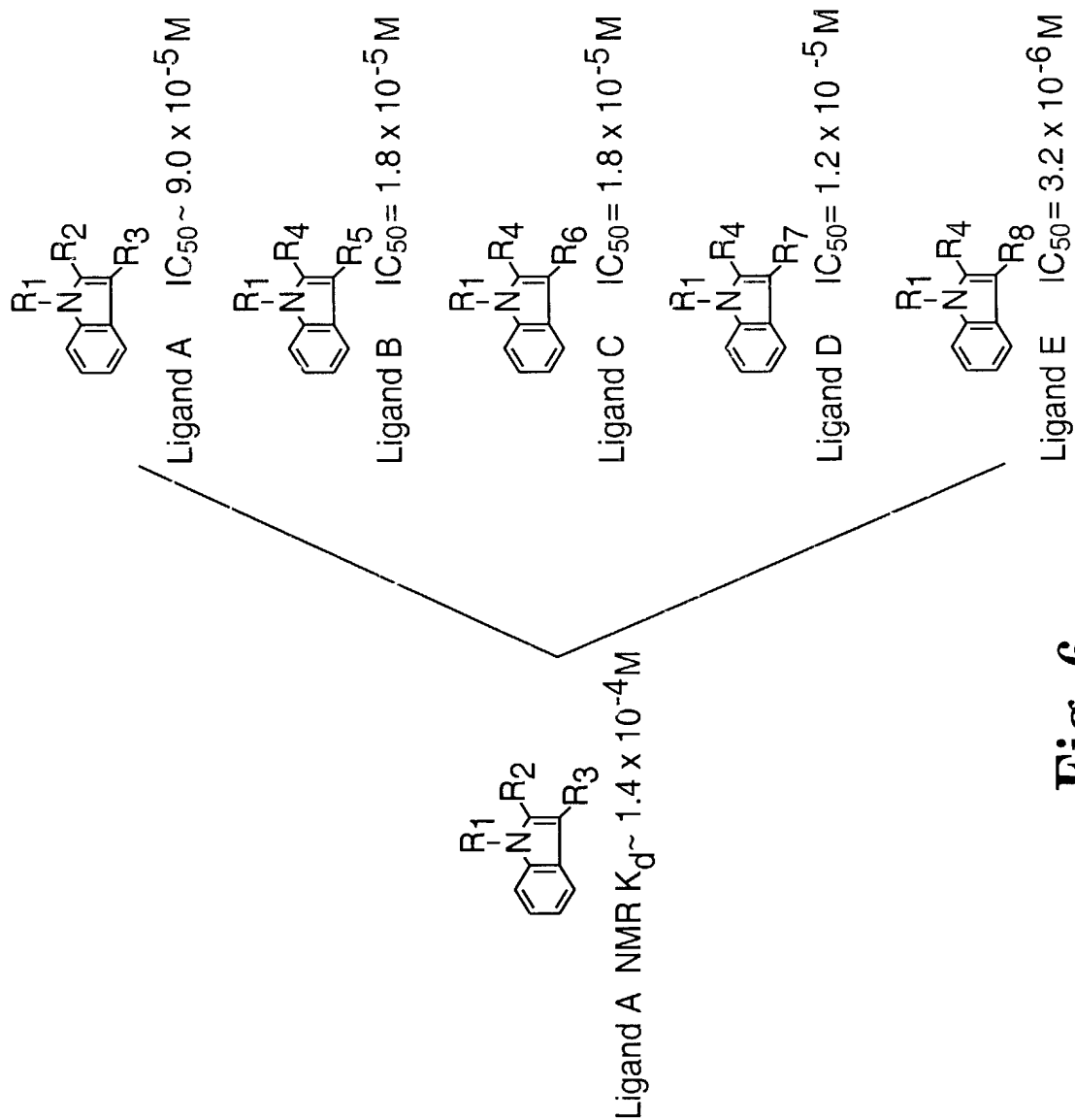
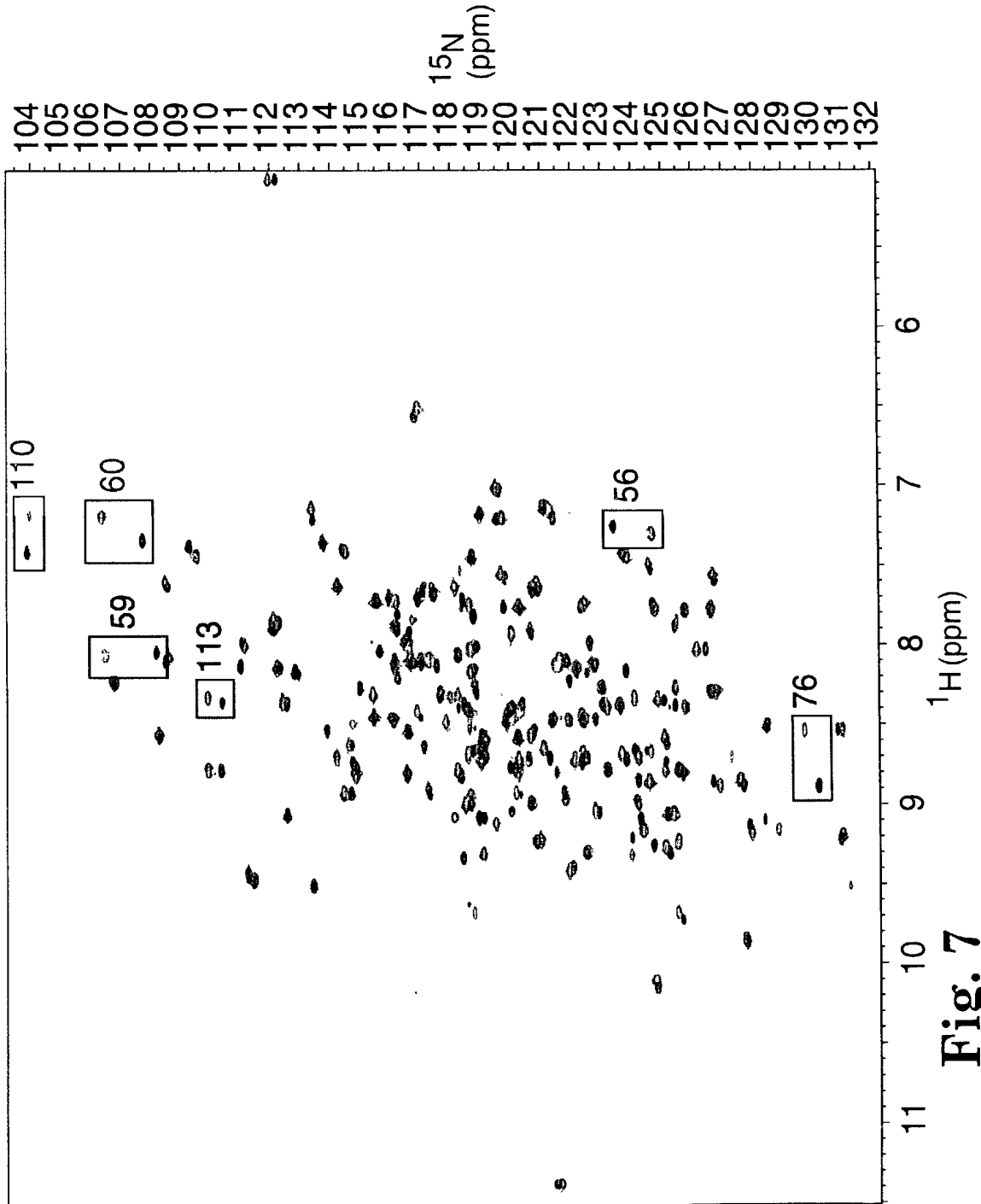
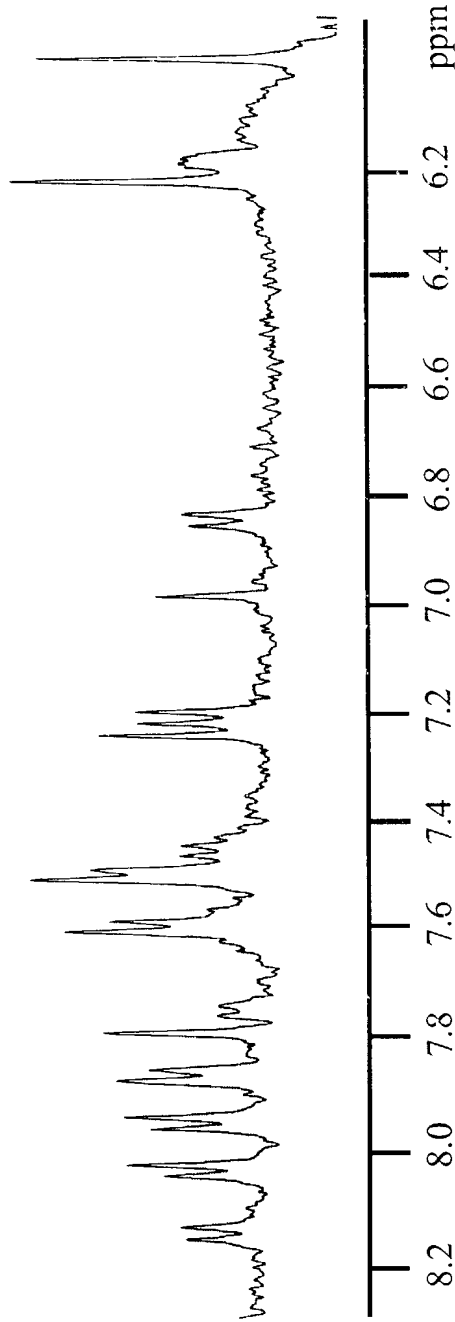


Fig. 6

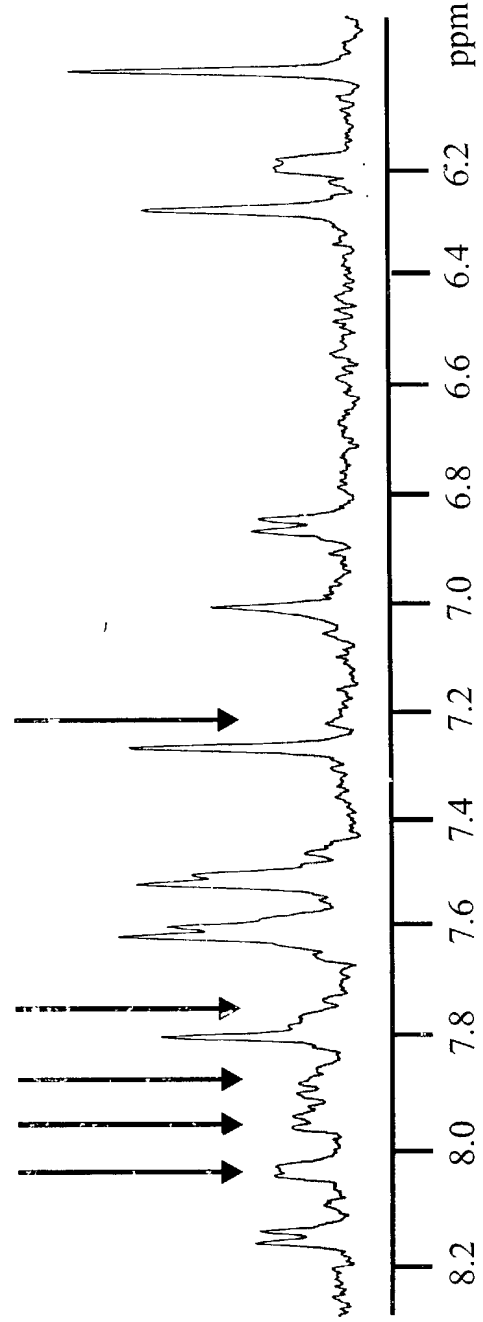
7/17



8/17



**Fig. 8A**



**Fig. 8B**



9/17

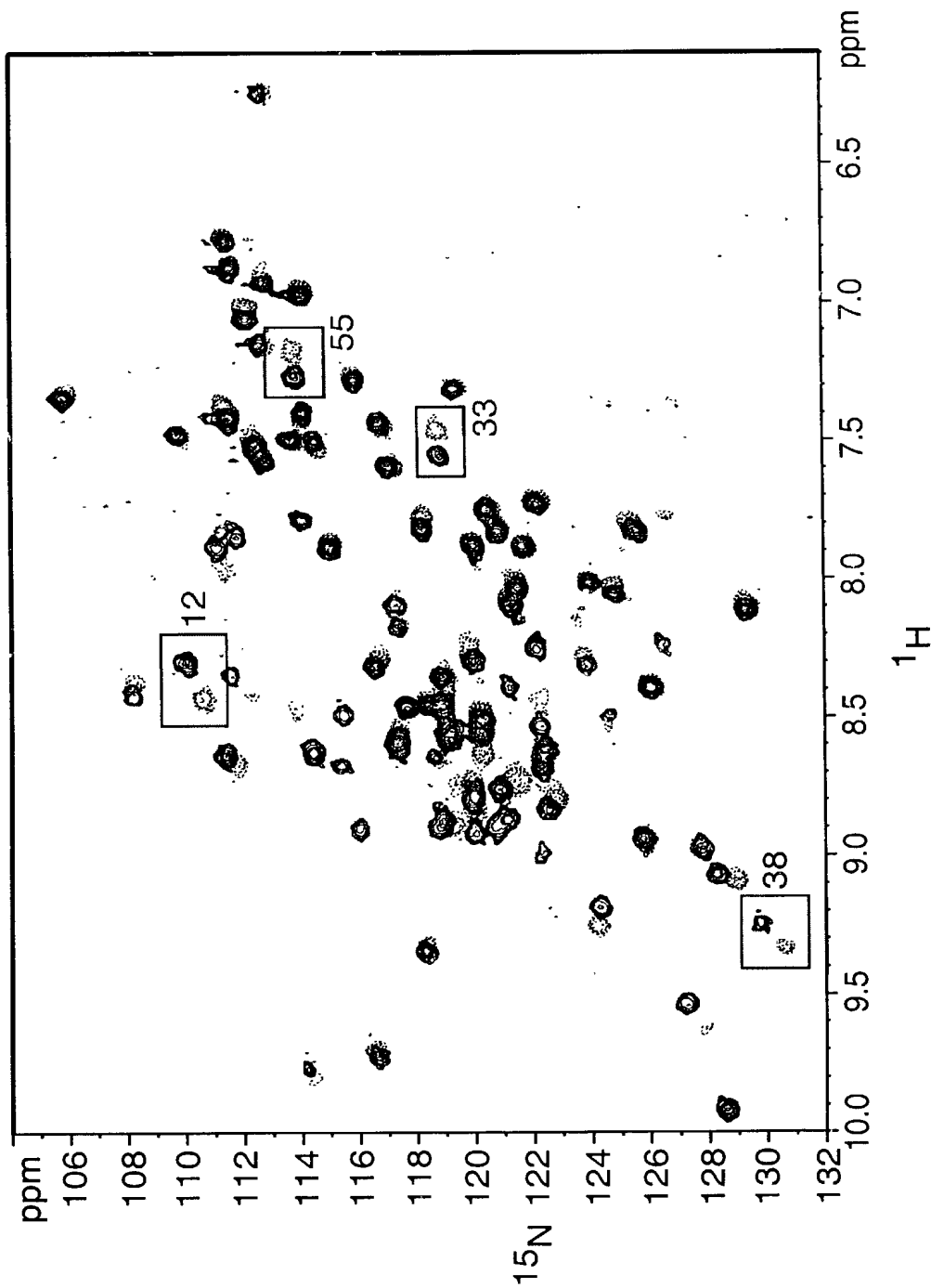
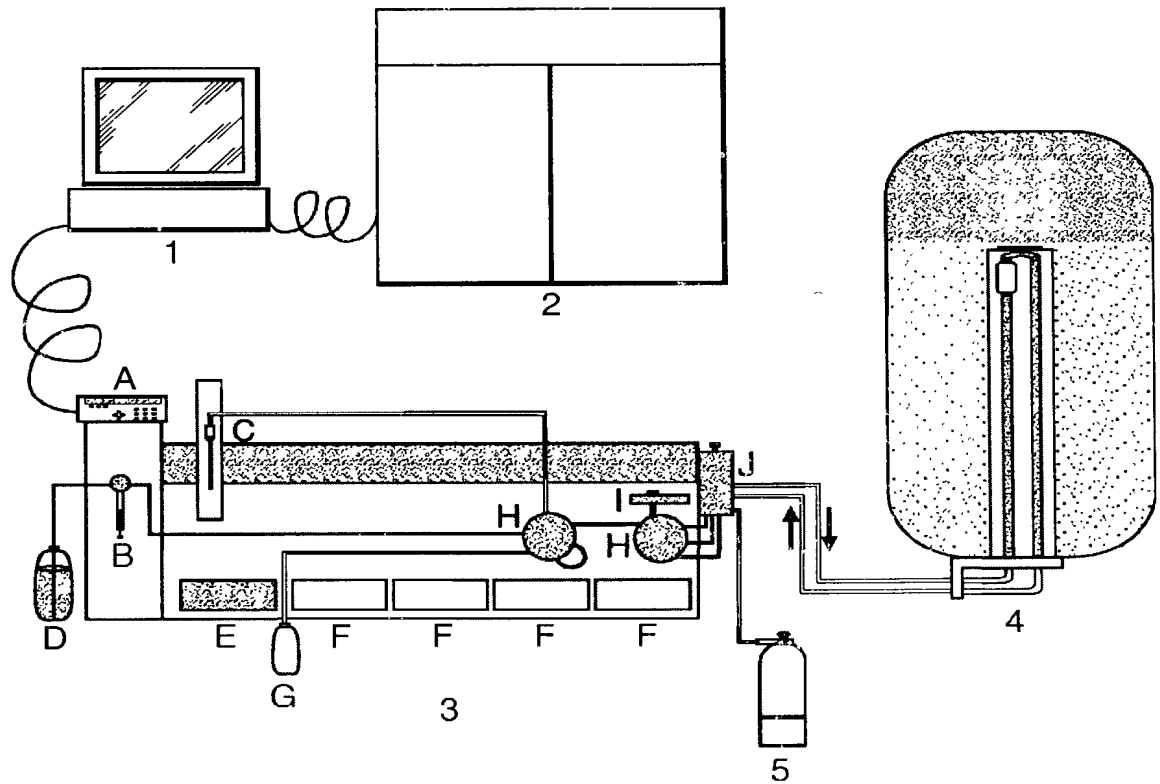


Fig. 9

10/17



**Fig. 10**

11/17

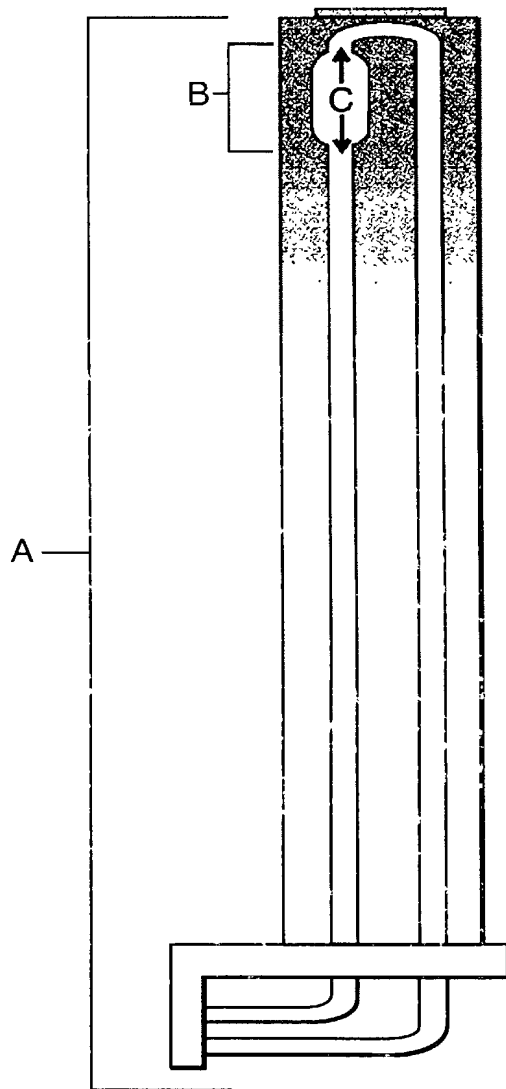
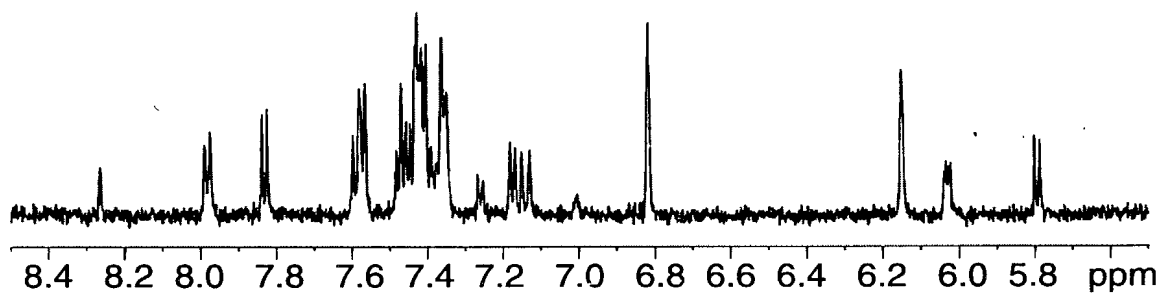
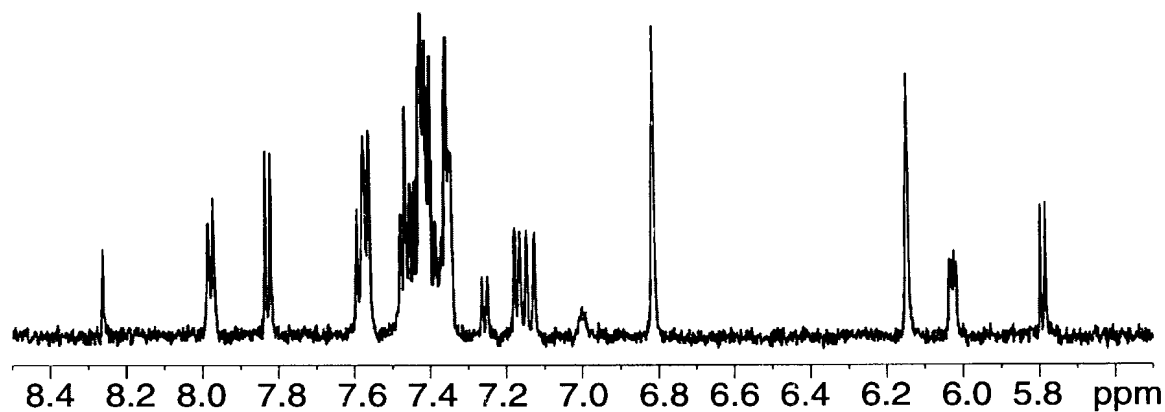


Fig. 11

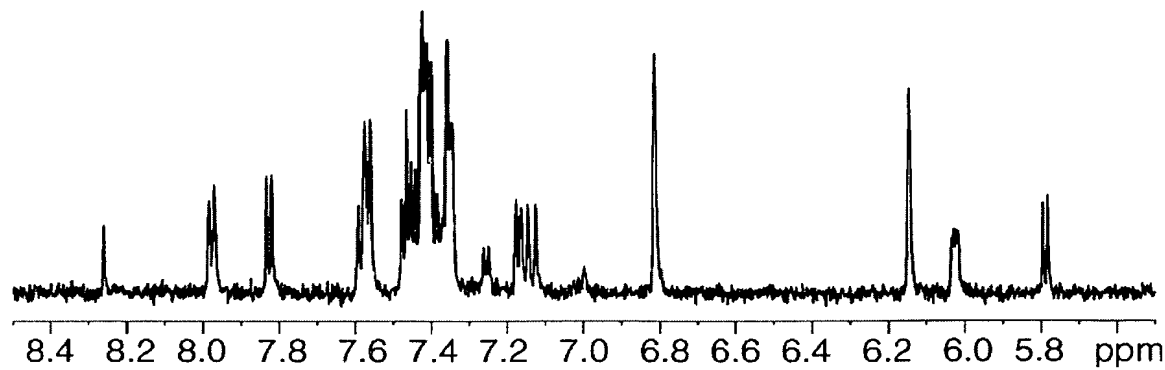
12/17



**Fig. 12A**

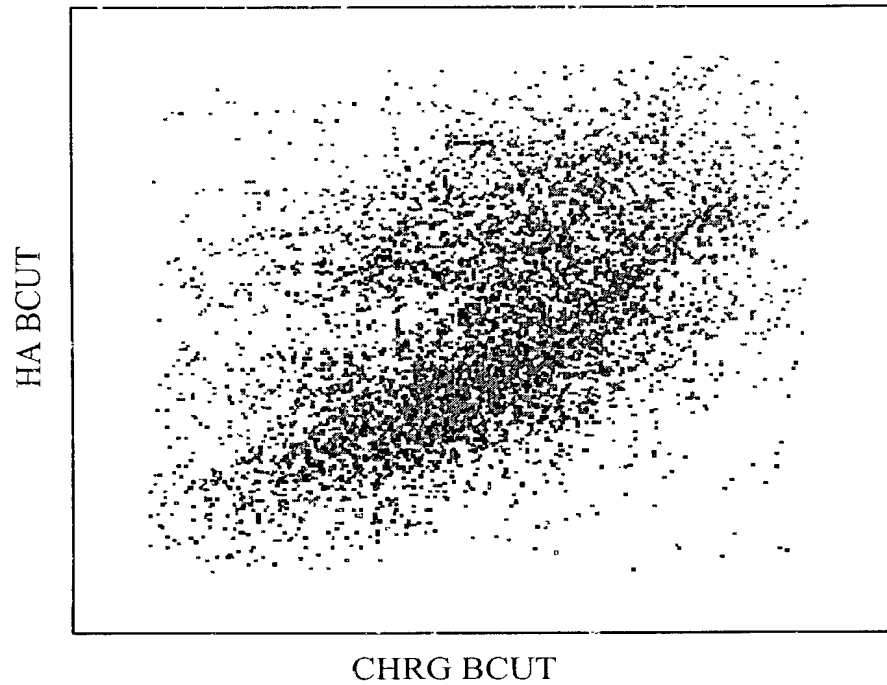


**Fig. 12B**



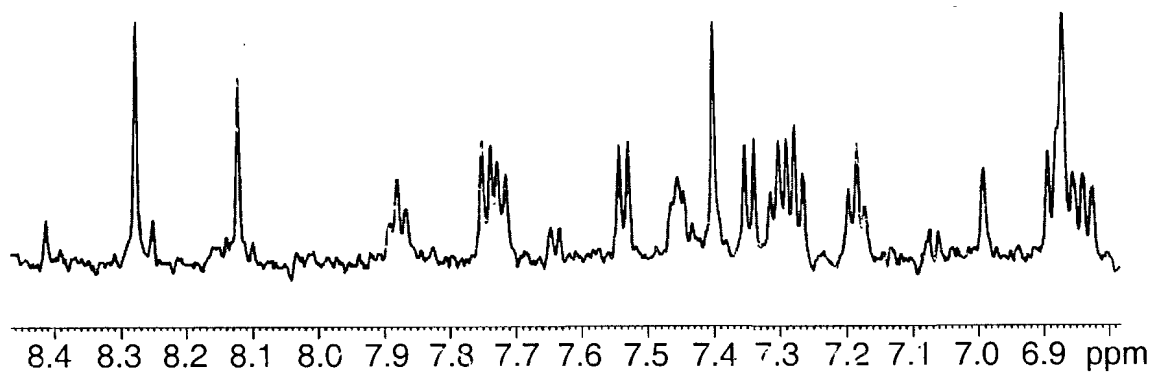
**Fig. 12C**

13/17

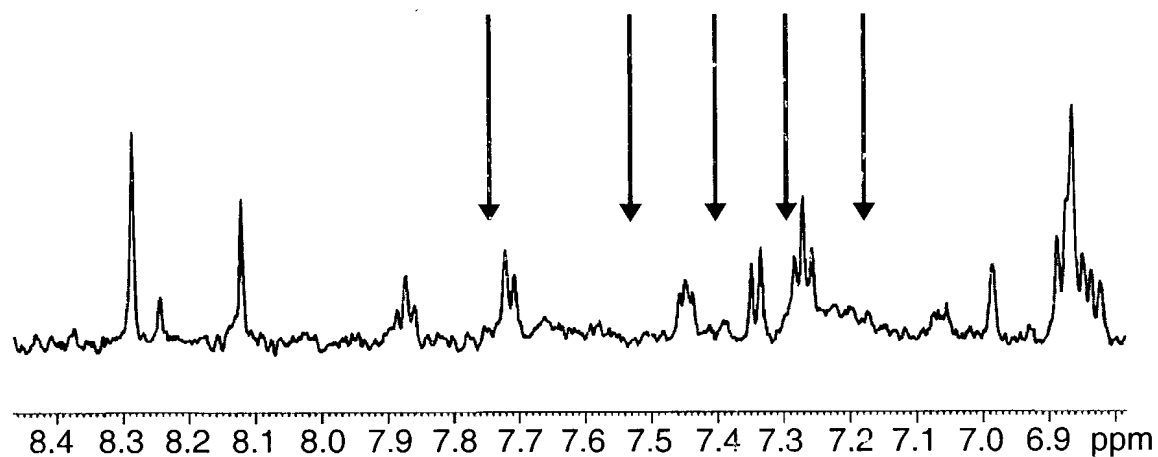


**Fig. 13**

14/17

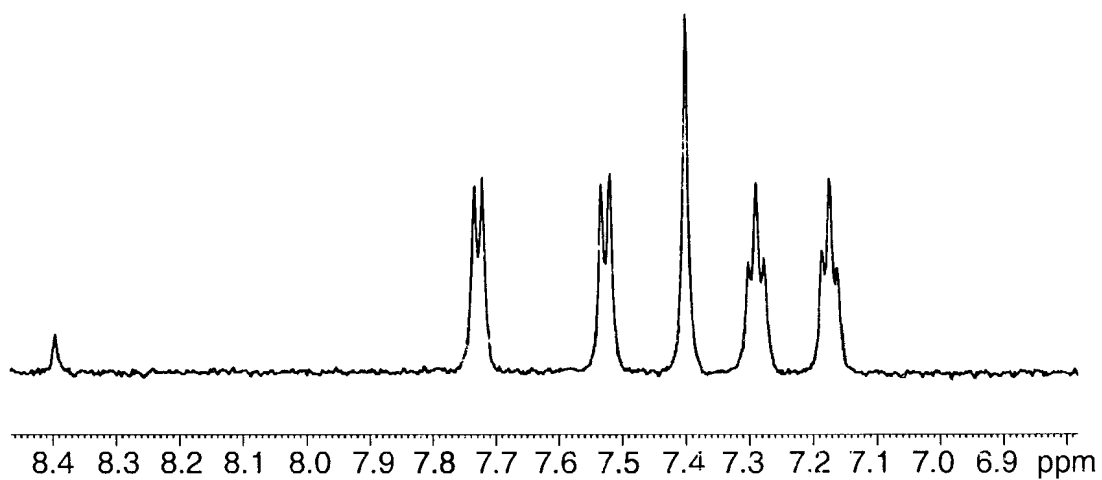


**Fig. 14A**

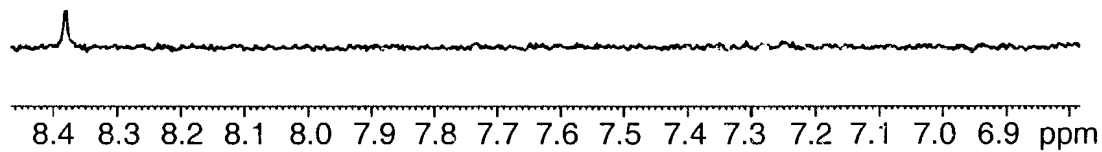


**Fig. 14B**

15/17

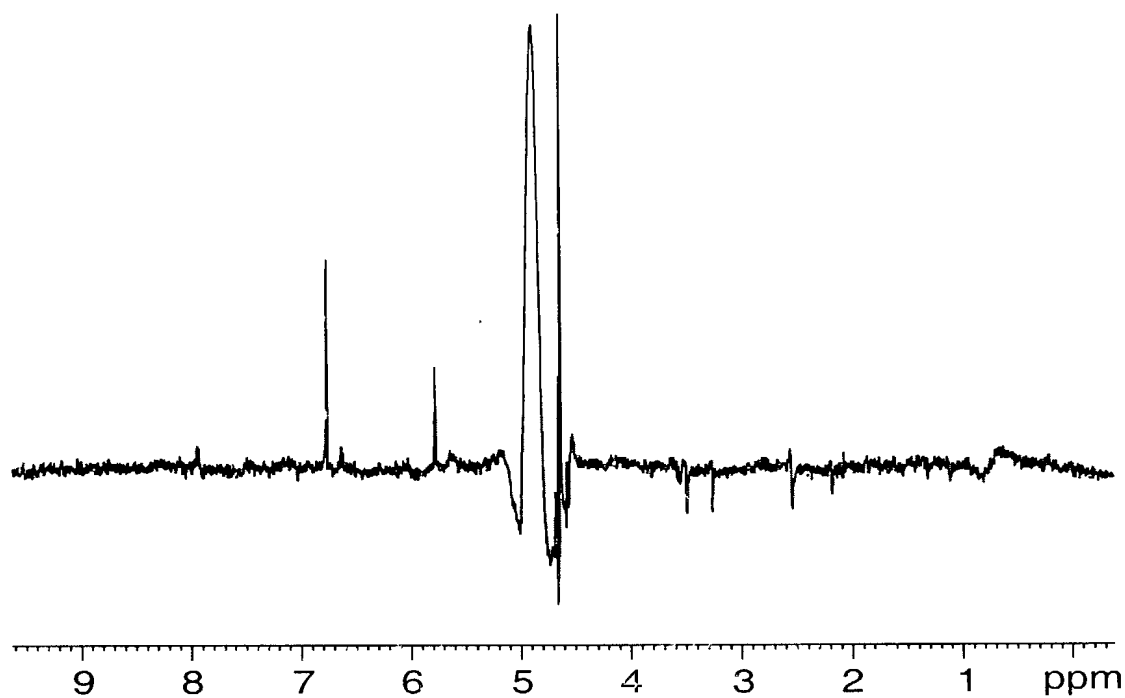


**Fig. 15A**



**Fig. 15B**

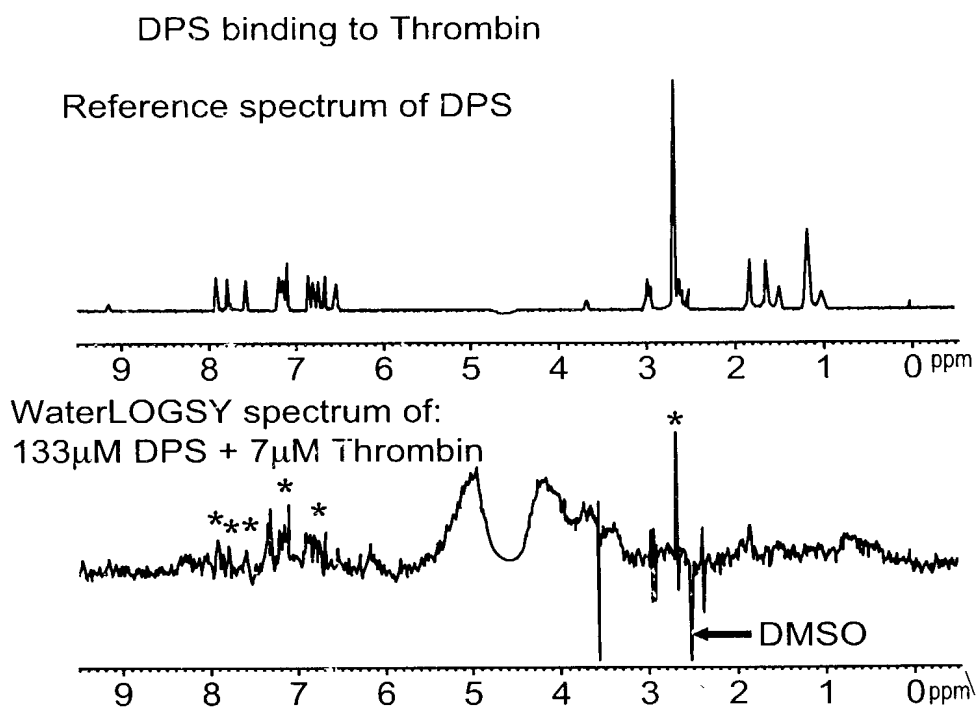
16/17



**Fig. 16**



17/17



**Fig. 17**